



*The SPEED of AIR with the
POWER of HYDRAULICS*

TUBE PIERCING

There are four basic components for tube piercing with Multicyl, *see >>*

>>1...Multicyl

Several Multicyl models are designed specifically for tube piercing. The short power stroke used for punching in flat sheet metal was extended in length for the longer requirements of tube piercing.

>>2...Cage

The design of a tube pierce cage allows for low tonnages and close hole positions. Special tooling is housed in a Multicage pillar style cage.

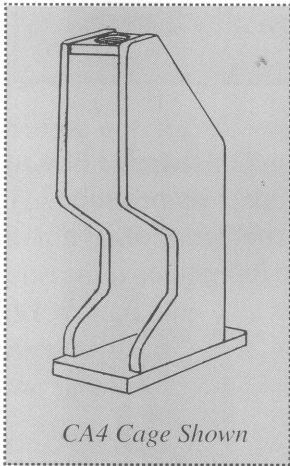

The standard tube pierce cage may be used along with the TP1 & TP2 Tube piercing units. Other C frame cages are also available for special applications.

>>3...Air Control Package- Safety

Controls for hole punching applications in flat sheet metal can usually meet all safety standards as the self-adjusting stroke can be set to a height where there is no operator nip point and a foot valve is approved. However, in tube piercing front feeding of the tube involves opening the tube guides beyond the approved safety limit. A Two Hand Anti-Tie Down Circuit is recommended unless external safety guards are used.

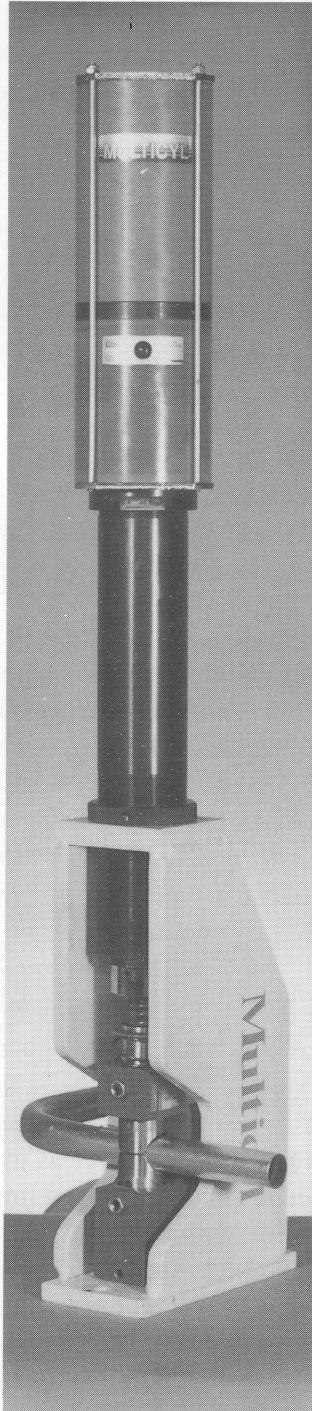

2½Ton Tube Pierce Unit Shown

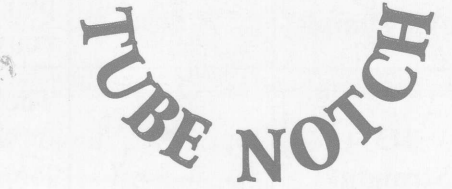
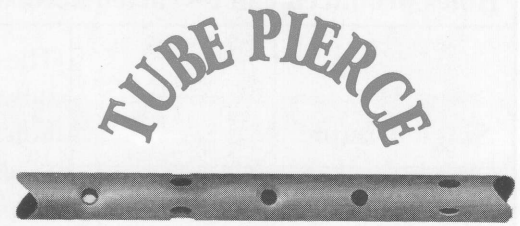

>>4...Tooling
Tube Pierce Unit Model #TP1
for hole styles H1, H2 & H3

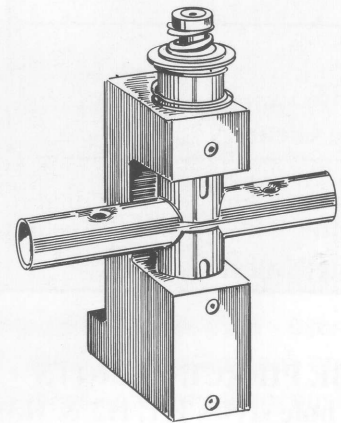





TP1 Shown

The standard tube piercing unit pierces dimpled holes in round or shaped tubing from one or both sides of the tube. Up to ½" diameter round or shaped punches may be used. For multiple holes a number of units may be combined for a gang punching system. Straight or preformed tubes may be punched preformed tubes.

For holes without a dimple a mandrel style of tool is required. Tube notching tools are also available.

See Tool Selection Chart (page 2) for details.

TOOL SELECTION CHART.... Tube piercing
Holes produced can be varied according to the style of tool used.

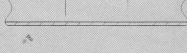
<p>H1 Single Dimple</p>		<p>The standard tube pierce unit #TP1 pierces holes through one or both sides of the tube with a dimple. Punches up to 1/2" in diameter. The standard unit will pierce holes in tube up to 1" in diameter. Guides are interchangeable to allow shaped tubes to be punched. Larger sizes available #TP2 up to 1/4" diameter - #TP3 up to 1 1/2" diameter. A Multicyl gang punching system uses a number of these units to punch components and may be performed after tube bending, an advantage to a conventional press which can only punch within the confines of the press bed.</p>
<p>H2 Double Dimple</p>		
<p>H3 Straight through</p>		<p>The straight through pierced hole produces a dimpled hole on top and a clean hole on the bottom in tube up to 1/4" maximum diameter. This hole style requires a long power stroke. There are several Multicyls available in either single or double acting models, depending on the tube size and hole configuration.</p>
<p>H4 Clean Hole</p>		<p>The #TPM125 mandrel style tube pierce unit pierces a clean hole in one side of the tube. The mandrel supports the inner wall of the tube and where required a lower support is used under the mandrel. Holes are usually close to the end of the tubing.</p>
<p>H5 Double Clean</p>		<p>Custom built tooling can pierce clean holes through both sides of the tube, using a supported mandrel. In order to avoid punching with the slug this may also be performed using 2 horizontally mounted cyls punching into a mandrel.</p>
<p>H6 Multiple Holes</p>		<p>Using different styles of custom tooling multiple holes can be pierced through one side or both sides of the tube. When using a mandrel style tool for clean holes on both sides the tube may need to be rotated for second hit.</p>

TUBE PIERCING UNITS
(for hole styles H1, H2 & H3)



The standard tube pierce unit is designed to pierce round or shaped holes up to 1/2" in diameter in one or both sides of tubing. Round or shaped tube guides allow quick changeover from one tube size to another. For front feeding of the tube, the external lifter spring opens the top guide.

On closing, the guides encapsulate the tube to prevent distortion, with the bottom guide depressing over the stationary punch. The dimple created as a result of the pierce operation may be used for seating the screw head. If the dimple is undesirable, there are several methods of improving the hole condition:

1. Distortion will be limited if the tube has thick walls or tougher material. Tonnage requirements will be higher.
2. A shear angle ground on the punch tip can reduce not only the dimple but also tonnage requirements. Caution must be taken however as using this procedure lengthens the power stroke needed for piercing, an important consideration especially when punching with Multicyl.
3. Straight through pierce units dimple only the top side of the tube, using the bottom guide as a die to produce a "clean" hole. Maintenance may be higher as this unit usually punches with the slug (H3 above). All models may be used for tube piercing within the stroke and tonnage ratings of the individual cyl. However, certain Multicyls are designed especially for tube piercing. When piercing from both sides, it may be necessary to limit the power stroke so that the total power is not used up by either upper or lower punches.

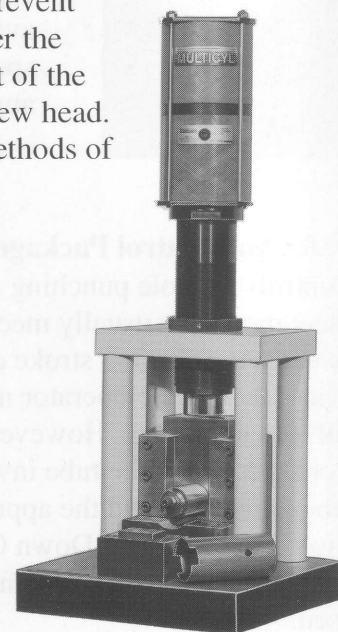

Unique mandrel tool pierces from the inside for burr free bore

MANDREL TUBE PUNCHING (for hole styles H4, H5 & H6)

Tube or Channel Mandrel Punching Units (H4 & H5)

For use where a dimple free hole is required. Round or shaped holes can be punched through a mandrel in round or shaped tubing. Hole positions are usually close to the end of the tube for reasons of mandrel strength (see photo). Double clean (H5) piercing may also be performed in a mandrel tube die. A mandrel style dieset would be used for piercing clean, dimple free holes deeper into the tube.

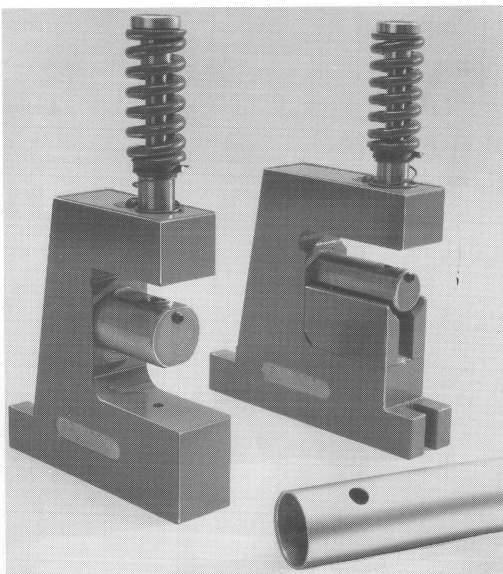

Tube or Channel Piercing Units			
Model #	TPM15	TPM20	TPM25
Maximum Hole Diameter	7/16"	5/8"	7/8"
Minimum/Max Tube Diameter	1" to 1½"	1" to 2"	1½" to 2"

Standard TPM units punch up to 1/8" thick material up to 2½" from the end of the tube. Mandrel supports may be supplied for certain tubes to prevent distortion. Tool steels may be varied to suit the application. For example, high speed steel or equivalent may be supplied for punching stainless steel or high volumes.

TUBE NOTCHING

Standard tube notchers can be set-up in individual or multiple cages powered by Multicyl. Off the shelf notching tools fit into cages with the Multicyl selected to suit tube tonnage and stroke requirements. The most common type of notch unit is the right angle notch (N1) which will notch round or shaped tubes at 90 degrees in two separate hits. The operator first notches one side then inverts the tube to notch the opposite side. As various types of tools are ground with shear on the punches, the Multicyl used should be selected with a stroke long enough to provide power throughout the working stroke.

Single notch (N1) - tooling uses standard Vogel or Project Tool housing to complete the notch one end in two operations.

N1.-Notch one side then revolve the tube 180 degrees the second hit. (Below)

Double notch (N2) - a more expensive option as two Multicyls are used. Completes one end of the tube using an internal mandrel powered horizontally first one way then the other in a cycle time of 2/3 seconds.

Two double notch tools (N3) - uses two double notchers one for each end, to complete both ends simultaneously. A secondary end motion is required to allow the tube to clear the tooling before it is fed onto the mandrel.

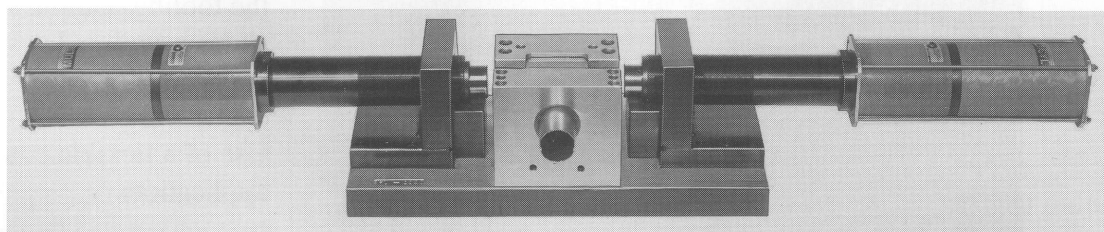
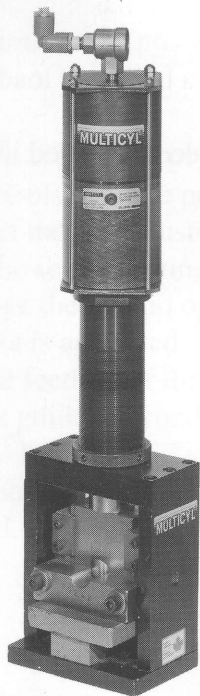

Many profiles of notches, slots and holes can be punched into tubes. Various materials include steel, aluminum, plastics, etc. Profiles can be round, square, rectangular. More recent developments include notching of non-symmetrical parts as shown in drawing

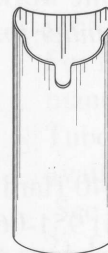

(Above) Two Horizontal Multicyls are used to notch (N2) one complete end of the tube using a mandrel punch.

ADVANTAGES OF TUBE PIERCING & NOTCHING WITH MULTICYL

- 1.Lower Cost** Initial capital outlay is less than conventional equipment such as punch presses or hydraulic punching machines.
- 2.Flexibility** Buy now and add more units for tomorrow's needs.
- 3.Safety** Small workstation, only one moving part, ideal, simple to safeguard.
- 4.Quick Set-Up** For gang piercing simply add or delete a tool station using shut off valves.
- 5.Compact Size** May be bench mounted to allow access for pierced holes as close as 4 1/2" centres with standard cages.
- 6.Portability** Connect a mobile workstation wherever shop air is available. Move the machine to the job if the parts are too big to move across the shop.
- 7.Punch Irregular Shapes** A number of units can be used for multiple piercing of long or irregular shaped parts.
- 8.Standard Tooling** Unitized tooling assures precise in line punching of holes in one or both sides of the tube.

Dedicated tooling ideal for short batch production

Five 2 1/2 Ton Multicycls were used in this unique application which pierced four holes and then "saddle-formed" tubular steel wheelchair components. Just-In-Time manufacturing techniques eliminated set-up time where the average run quantity was 200 pieces. Flexible manufacturing was assured as this mobile machine may be connected close to any available tube bender in the plant at the time of production.

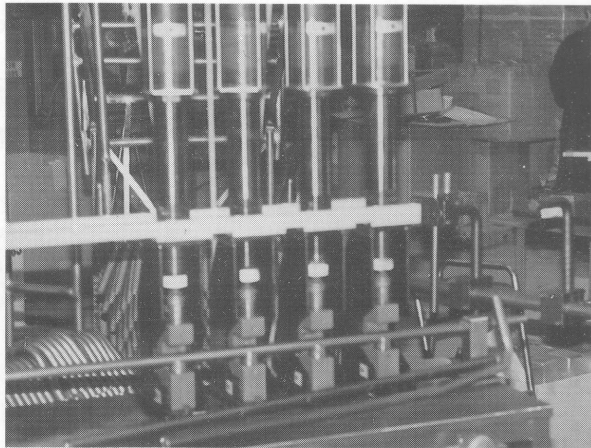

Cellular Manufacturing Tubular steel components are formed and pierced on a mobile work station which is located beside the most convenient bender for the next operation.

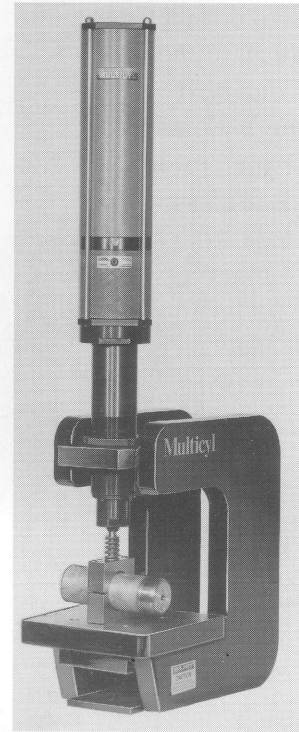

For larger diameters the DX Series may be used to pierce through tubes using special tooling

Double Acting

For applications where longer overall and power stroke may be required, use the DM or DX series. Tooling (usually up to 200 lbs max) may be fastened to the ram. The use of a flexible coupler isolates the cylinder from off centre loading. The secret to success is to balance the load within the tooling. Unlike a press which has gibs and slides a Multicyl system relies on the accuracy and ability of the tool to provide a balanced load condition.

Use of a flexible coupler is recommended in dieset applications.

MULTICYL Inc.

640 Hardwick Road, Unit 5, Bolton, Ontario Canada L7E 5R1

Tel:(905) 951-0670 ● Fax:(905) 951-0672 ● U.S. Toll Free 1-800-388-6359

Check out our WEBSITE for some COOL PUNCHING IDEAS! [HTTP://WWW.MULTICYL.COM](http://WWW.MULTICYL.COM).